

fixings & supports

Thermoplastic piping systems are often installed in corrosive environments, particularly in chemical and process applications. In these situations, traditional metallic supports will suffer excessive degradation unless they are manufactured from expensive stainless steel. A more cost effective choice is to use non-metallic fixings from the ranges featured here.

Clic pipe clamps are designed for fixing a wide range of piping materials and cables, and they can be used on almost any diameter from 8mm to 127mm. Manufactured in nylon (Polyamide PA12), they are safe for use at temperatures from -40°C to +80°C.

The Clic range also includes a wide range of fixings, mountings and spacers to make the most complicated installation simple.

The IBG, Durapipe and AGRU range of pipe clips includes supports for both inch and metric sized plastic piping systems.

section guide

Clic Pipe and Cable Clamps	524
Clic Accessories	525
IBG Pipe Clips - mm Sizes	526
Agro Pipe Clips - mm Sizes	526
IBG Pipe Clips - Inch Sizes	527
Durapipe Pipe Clips	527

application guide

- All plastic systems
- Lightweight
- Ideal in corrosive environments
- Will support pipes made from plastics or metals, as well as cables
- Versatile choice of systems
- Range of diameters from 8mm to 400mm



IPS Flow Systems

Seaham Grange Industrial Estate, Seaham, Co Durham, SR7 0PT, England

Tel: +44+ 191 521 3111 Fax: +44+ 191 521 3222

E-mail: sales@ipsflowsystems.com Website: www.ipsflowsystems.com

cllc clamps

for pipes, conduits and cables

CLIC pipe clamps are designed to complement a wide range of piping materials, conduits and cables

Available in a choice of 21 sizes, covering diameters ranging from 8mm to 127mm, this patented design uses a ratchet principle to securely lock the pipe in place whilst still allowing axial movement.

The use of a ratchet lock means each CLIC clamp will accommodate a range of diameters, and in many cases one CLIC clamp will hold both imperial and its equivalent metric pipe size, eliminating the need for unique fit clips.

Manufactured from dark or light grey nylon (Polyamide PA12), CLIC clamps are suitable for use within a temperature range of -40°C to +150°C, and the material is unaffected by climatical conditions.

CLIC, however is not simply a range of pipe and cable clamps - it is a "complete fixing system" which includes multiple plate mountings, spacers to offset clamps, and a variety of adaptors for connection to threaded rods, wall plates and concrete.

The versatility of the system provides unlimited opportunities to install pipes in even the most difficult situations, and it offers the flexibility to combine the use of CLIC fixings with channel framing systems.

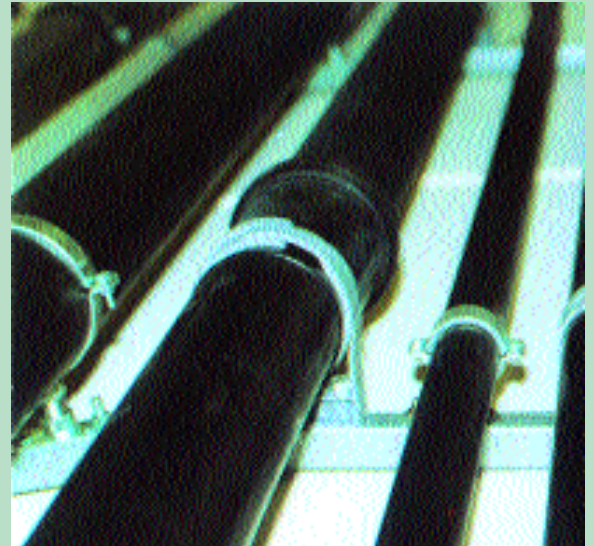
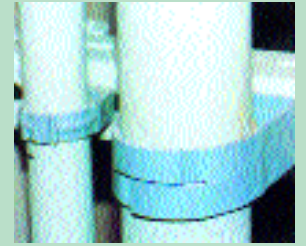
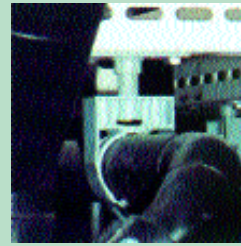

Features of the clic pipe clamps

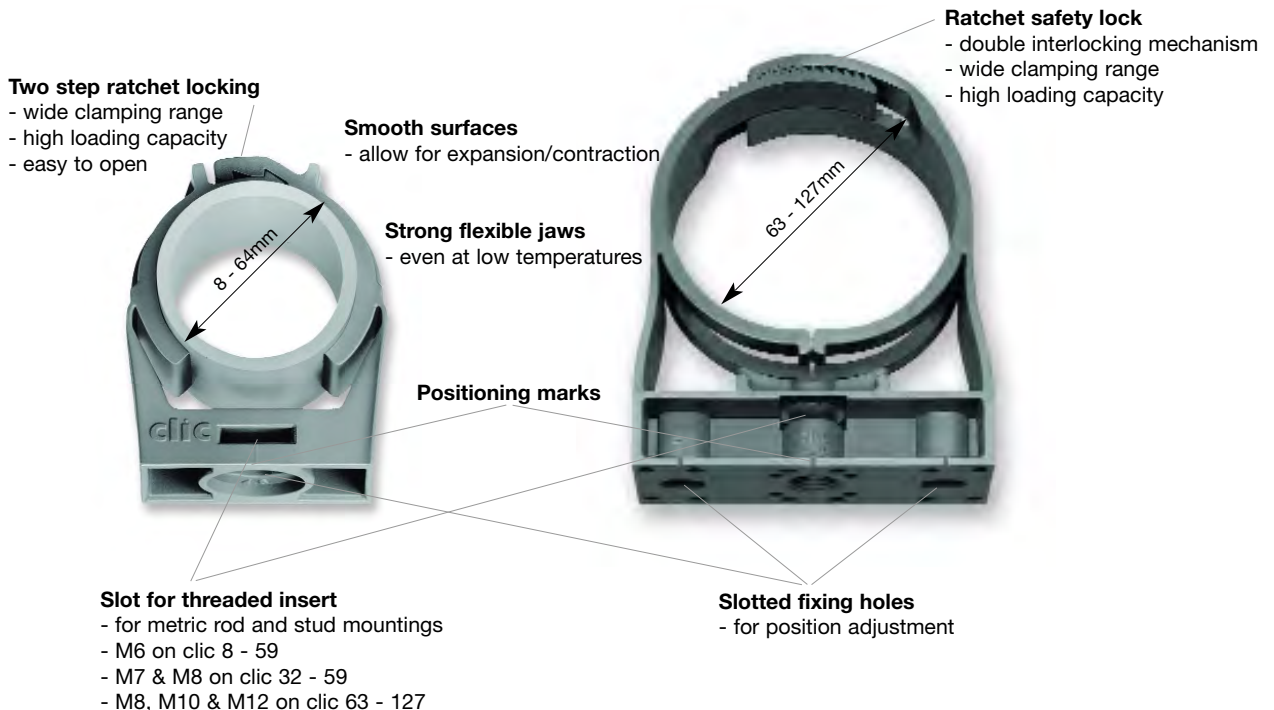

Application Guide

	clamping range o.d. mm	mm pipe size	inch pipe size	copper pipe size	conduit pipe size
clíc 8	7.8-9.5	8		8	
clíc 10	9.5-11.8	10		10	
clíc 12	11.8-14.3	12	1/4"	12	
clíc 15	14.3-16.8	16		15	16
clíc 17	16.8-19.5		3/8"		
clíc 20	19.5-22.0	20	1/2"		20
clíc 22	22.0-23.0			22	
clíc 25	24.6-27.8	25	3/4"		25
clíc 28	27.8-31.2			28	
clíc 32	31.2-35.5	32	1"	35	32
clíc 36	35.5-39.5				38
clíc 40	39.5-43.5	40	1 1/4"	42	
clíc 47	46.5-50.5	50	1 1/2"	50	
clíc 51	50.5-55.5			54	
clíc 59	58.5-64.0	63	2"	64	
clíc 63	63.0-71.0	63		66.5	
clíc 71	71.0-80.0	75	2 1/2"	76	
clíc 80	80.0-90.0		3"	89	
clíc 90	90.0-101.0	90			
clíc 101	101.0-113.0	110		108	
clíc 113	113.0-127.0	125	4"	114	

clíc®



Installation Options

By using the wide range of Clíc spacers and fixings, numerous installation techniques are possible.

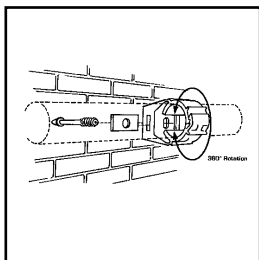

Brick and Blockwork

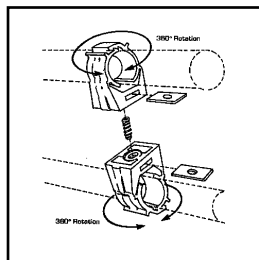

Pipe to Pipe

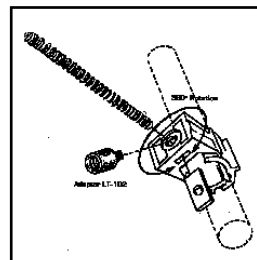

Threaded Rod

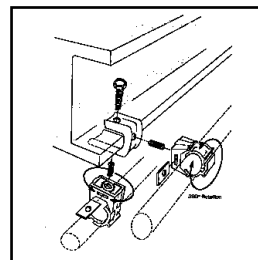

Beam Clamp

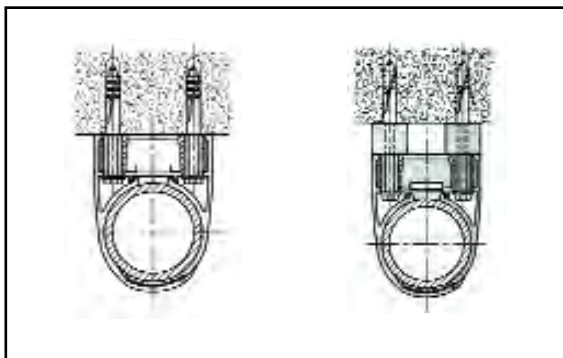

Clíc 8-59 fixing possibilities

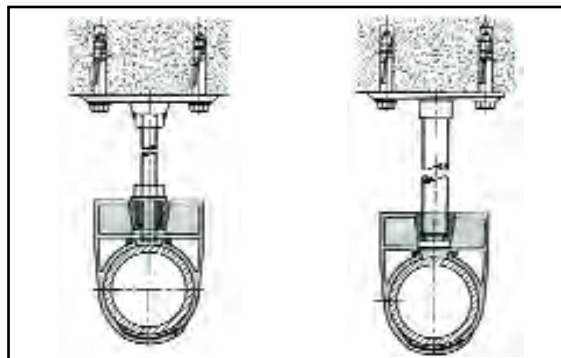

Clíc 63-113 fixing possibilities

CLIC Pipe Clamps dia 8-64mm



	dark grey code	clamping range o.d. mm	wood screw mm	max load n	pcs./carton	price
clíc 8	A88.900	7.8-9.5	3.5	450	100	0.25
clíc 10	A88.901	9.5-11.8	3.5	500	100	0.26
clíc 12	A88.902	11.8-14.3	3.5	550	100	0.34
clíc 15	A88.903	14.3-16.8	3.5	600	100	0.34
clíc 17	A88.904	16.8-19.5	4.5	650	100	0.38
clíc 20	A88.905	19.5-22.0	4.5	700	100	0.44
clíc 22	A88.906	22.0-23.0	4.5	750	100	0.48
clíc 25	A88.907	24.6-27.8	4.5	850	50	0.60
clíc 28	A88.908	27.8-31.2	4.5	900	50	0.64
clíc 32	A88.909	31.2-35.5	4.5	1000	50	0.84
clíc 36	A88.910	35.5-39.5	4.5	1100	50	0.90
clíc 40	A88.911	39.5-43.5	4.5	1150	25	1.19
clíc 47	A88.912	46.5-50.5	4.5	1300	25	1.51
clíc 51	A88.913	50.5-55.5	4.5	1400	25	1.62
clíc 59	A88.914	58.5-64.0	4.5	1600	20	1.92

Light Grey available to order and may be subject to minimum quantity

CLIC Pipe Clamps dia 63-127mm



	dark grey code	clamping range o.d. mm	wood screw mm	threaded stud fixing	max load n	pcs./carton	price
clíc 63	A88.340	63.0-71.0	10.0	1/2"	1000	25	3.84
clíc 71	A88.341	71.0-80.0	10.0	1/2"	1300	25	4.28
clíc 80	A88.342	80.0-90.0	10.0	1/2"	1600	25	4.74
clíc 90	A88.343	90.0-101.0	10.0	1/2"	1900	25	6.01
clíc 101	A88.344	101.0-113.0	10.0	1/2"	2200	25	6.51
clíc 113	A88.345	113.0-127.0	10.0	1/2"	2500	25	7.35

Light Grey available to order and may be subject to minimum quantity

CLIC Dimensions

nominal clíc size	b	c	d	e	j	k
8	17.1	17.5	26.4	17.1	7.5	4.3
10	17.1	16.6	26.2	17.1	7.5	3.0
12	23.6	18.4	29.9	20.2	7.5	3.4
15	23.7	18.6	30.0	20.3	7.5	2.4
17	27.0	22.0	35.4	22.5	7.8	3.4
20	29.5	23.7	39.4	24.8	7.2	3.2
22	35.1	25.0	40.9	29.0	8.6	3.8
25	35.8	26.8	45.1	30.4	8.8	2.8
28	39.7	28.8	48.9	33.4	8.8	3.5
32	44.7	32.2	54.4	38.0	9.0	3.5
36	49.1	34.3	59.4	41.8	9.1	4.1
40	53.2	36.3	64.2	46.2	9.3	3.7
47	61.3	40.6	72.8	53.5	9.8	4.1
51	67.0	44.3	78.7	58.6	10.2	4.1
59	76.6	48.6	88.2	66.3	10.7	4.2
63	79.0	72.0	115.0	78.0		
71	91.0	77.0	124.0	87.0		
80	102.0	83.0	136.0	98.0		
90	111.0	89.0	148.0	110.0		
101	124.0	96.0	163.0	124.0		
113	143.0	105.0	180.0	139.0		

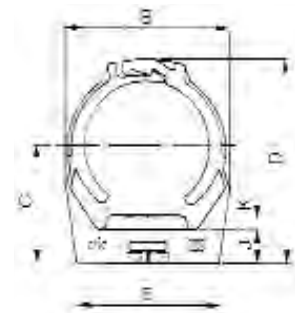

clíc 8-64

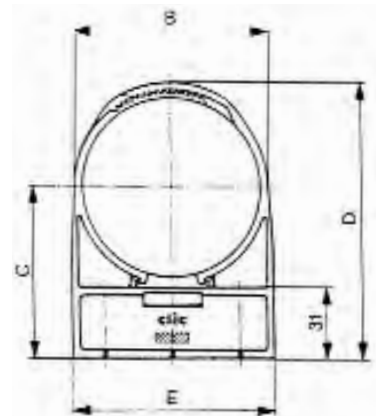

clíc 63-127

Spacer

Polyamide - Light Grey
Can be plugged into and combined with one another.



height	2.5mm	5mm	15mm	25mm	35mm	45mm	65mm	85mm
dimensions	20 x 24mm	20 x 24mm	20 x 30mm	20 x 30mm	20 x 30mm	20 x 30mm	20 x 30mm	30 x 50mm
pcs./carton	100	100	100	100	100	100	50	50
code	A88.260	A88.261	A88.262	A88.263	A88.264	A88.265	A88.266	A88.267
price	0.33	0.37	0.50	0.55	0.67	0.78	0.99	1.17

Base Plate

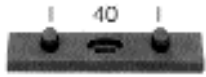

Polyamide
For mounting 2 clamps
dic range 8-25

code	description	pcs/carton	price
A88.270	Base plate dark grey 70 x 20 x 5	50	0.39
A88.272	Base plate light grey 70 x 20 x 5	50	0.42

Base Plate



Polyamide
For mounting 3 clamps
dic range 8-25

code	description	pcs/carton	price
A88.271	Base plate dark grey 110 x 20 x 5	25	0.45
A88.273	Base plate light grey 110 x 20 x 5	25	0.41

CLIC Flange M6



For mounting clic range 8-59
using M6 threaded stud or rod

code	description	pcs/carton	price
A88.130	M6 flange, zinc plated	100	0.14
A88.240	M6 flange, stainless steel	100	0.58

CLIC Flange M7 & M8



For mounting clic range 32-59
using M7 or M8 machine screw or rod

code	description	pcs/carton	price
A88.201	M7 flange, zinc plated	100	0.21
A88.285	M8 flange, zinc plated	100	0.34
A88.286	M8 flange, stainless steel	100	2.43

CLIC Flange M8, M10 & M12



For mounting clic range 63-113
using M8, M10 or M12 threaded rod

code	description	pcs/carton	price
A88.382	M8 flange, zinc plated	25	1.67
A88.381	M10 flange, zinc plated	25	1.72
A88.386	M10 flange, stainless steel	25	3.56
A88.385	M12 flange, stainless steel	25	3.62

Wood Screw



Stainless Steel
with pressed-on washer

code	description	pcs/carton	price
A62.182	Screw dia. 4.5 x 40 T25 head	100	0.38
A62.178	Screw dia. 4.5 x 50 T25 head	100	0.43
A62.184	Screw dia. 4.5 x 70 T25 head	100	1.00
A62.179	Screw dia. 4.5 x 90 T25 head	100	1.04
A62.181	Screw dia. 4.5 x 110 T25 head	100	1.10
A62.185	Screw dia. 4.5 x 125 T25 head	100	1.38
A62.186	Screw dia. 4.5 x 135 T25 head	100	1.49

Machine Screw



code	description	pcs/carton	price
A63.100	Machine Screw M6/6 x 45	100	0.25
A75.593	Machine Screw M8/6 x 40	100	0.28
A75.594	Machine Screw M8/6 x 60	100	0.37
A75.595	Machine Screw M8/6 x 80	100	0.42
A75.596	Machine Screw M8/6 x 125	100	1.88

Delta Nylon Plug



code	description	pcs/carton	price
A10.101	DELTA 5 for screw dia 3-4	100	0.02
A10.102	DELTA 6 for screw dia 3.5-5	100	0.03
A10.104	DELTA 8 for screw dia 5-6	100	0.04

Double Threaded Stud



for mounting using
clic M6 flange

code	description	pcs/carton	price
B16.111	M6/M6 x 12, zinc plated	100	0.13
B16.115	M6/M6 x 12, stainless steel	100	0.67
A75.590	M8/M8 x 12, zinc plated	100	0.61

pipe clips - mm sizes

IBG MM Pipe Clips

- ✓ Manufactured from black Polypropylene
- ✓ Sizes from 10mm to 400mm
- ✓ Suitable for metric sized systems in all materials



Type AA

Size	Code	Price
10	606680	0.34
12	606690	0.36



Type A

Size	Code	Price
16	606700	0.48
20	606710	0.60
25	606721	0.71
32	606731	0.84

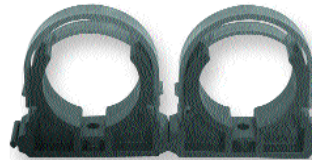

Type B

Size	Code	Price
25	606720	0.84
32	606730	0.97
40	606740	1.30
50	606750	1.64
63	606760	2.14
75	606770	3.18
90	606780	4.33



Type C

Size	Code	Price
110	606790	6.30
125	606800	8.30
140	606810	9.23
160	606820	10.78
200	606830	17.03
225	606840	18.43



Type D

Size	Code	Price
90	526090	5.54
110	606842	6.46
125	606843	8.79
140	606844	10.70
160	606845	12.20
200	606846	17.73
225	606847	20.58
250	606850	26.10
280	606860	30.49
315	606870	33.34
355	606880	42.26
400	606890	45.65

Agru Pipe Clips

- ✓ Manufactured from black fibreglass reinforced Polypropylene
- ✓ Sizes from 63mm to 225mm
- ✓ Complete with stainless steel clamp and screw
- ✓ For use with AGRU Polypropylene and PVDF restraining fitting.

Size	Code	Price
63	14 049 0063 00	8.45
75	14 049 0075 00	9.85
90	14 049 0090 00	10.15
110	14 049 0110 00	10.93
125	14 049 0125 00	12.05
140	14 049 0140 00	20.28
160	14 049 0160 00	22.12
180	14 049 0180 00	24.82
200	14 049 0200 00	38.43
225	14 049 0225 00	42.54



IBG Inch Pipe Clips

- Manufactured from black Polypropylene
- Sizes from 1/4" to 8"
- Suitable for inch sized systems in all materials



Type A

Size	Code	Price
1/4"	523012	0.36
3/8"	523016	0.48
1/2"	523020	0.60
3/4"	523025	0.71
1"	523032	0.84



Type B

Size	Code	Price
1 1/4"	523040	1.30
1 1/2"	523050	1.64
2"	523063	2.14
2 1/2"	525075	3.18
2 1/2"*	523080	3.18

*To suit ASTM sized pipes



Type D

Size	Code	Price
3"	526090	5.54
4"	523504	6.46
5"	526140	10.70
6"	523506	12.20
8"	523508	20.58

Durapipe Cobra Pipe Clips

- Manufactured from black Polypropylene
- Sizes from 12mm to 160mm (3/8" to 6")
- Suitable for both inch and metric systems



Size	Code	Price
12	13 434 304	0.50
3/8"/16	13 434 305	0.79
1/2"/20	13 434 306	0.93
3/4"/25	13 434 307	0.99
1"/32	13 434 308	1.10
1 1/4"/40	13 434 309	1.48
1 1/2"/50	13 434 310	1.61
2"/63	13 434 311	2.03
2 1/2"/75	13 434 312	3.96
3"/90	13 434 313	4.71
4"/110	13 434 314	6.54
125	13 434 315	10.61
5"/140	13 434 316	11.56
6"/160	13 434 317	12.55

12 to 32mm (3/8" to 1") not supplied with retaining straps

Durapipe Saddle Clips

- Manufactured from black Polypropylene
- Sizes from 3/8" to 4"
- Suitable for inch sized pipes



Size	Code	Price
3/8"	03 455 101	0.57
1/2"	03 455 102	0.62
3/4"	03 455 103	0.80
1"	03 455 104	1.01
1 1/4"	03 455 105	1.08
1 1/2"	03 455 106	1.35
2"	03 455 107	2.06
3"	03 455 109	4.50
4"	03 455 110	5.41

Don't see what you want?

We have access to a huge range of products that are not featured in our Handbook.

If you don't see what you want, give our team a call.

